

Safety Labels:

- 1 81-2015G
- 2 81-2015A
- 3 81-2015G
- 4 81-2015F

4 81-2015F
ON VERTICAL AUGER HOUSING,
JUST BENEATH TOP OF YELLOW
SNOW BREAKER FRAME

Safety Labels

1 81-2015G



2 81-2015A

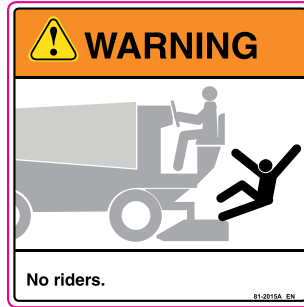

3 81-2015G

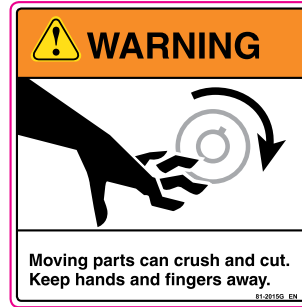

4 81-2015F

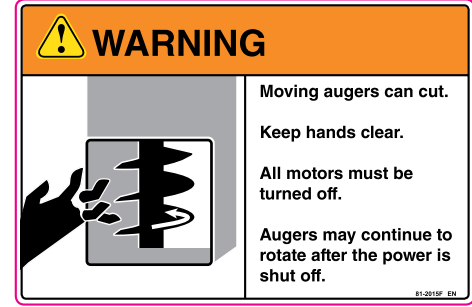

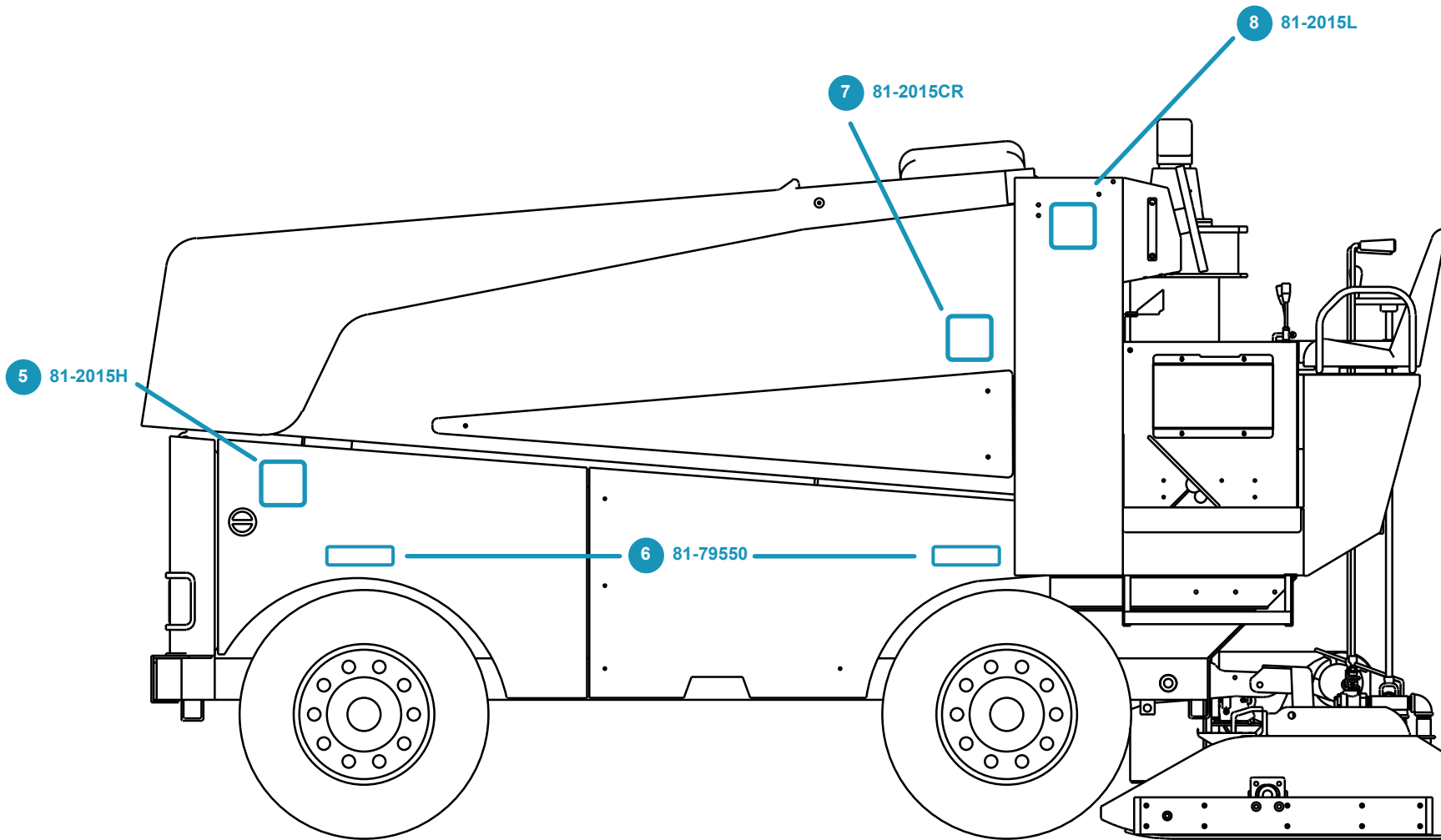

Safety Labels:

- 5 81-2015H
- 6 81-79550
- 7 81-2015CR
- 8 81-2015L

Safety Labels

5 81-2015H

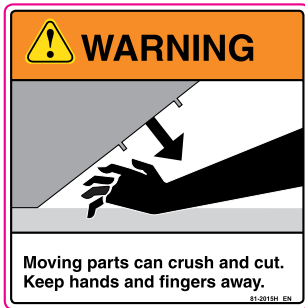

6 81-79950

75 psi / 500 kPa
81-79950

7 81-2015CR



8 81-2015L

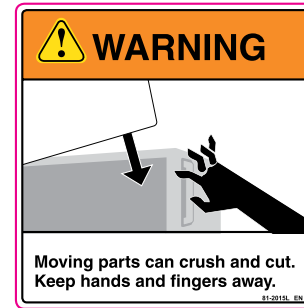

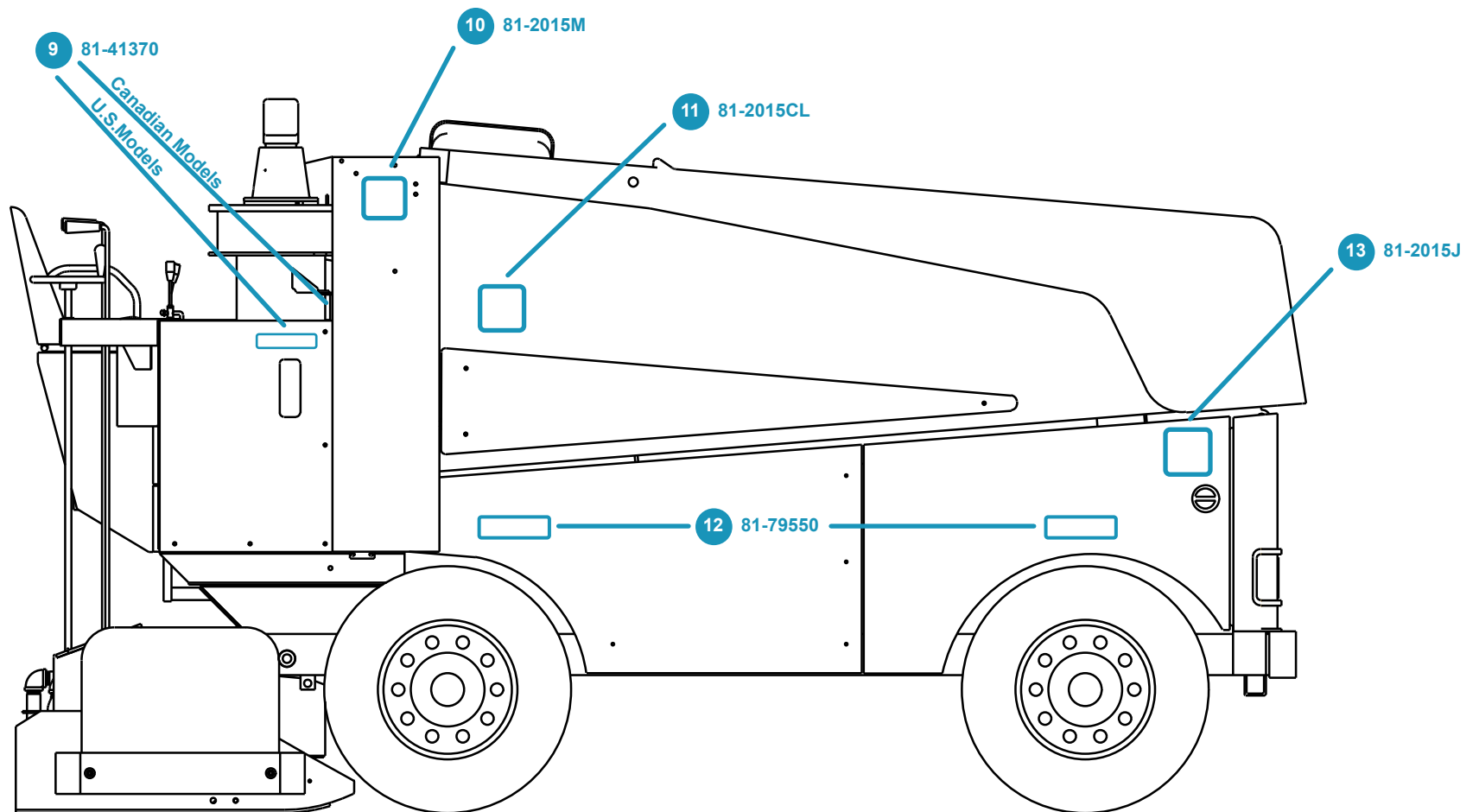

Safety Labels:

- 9 81-41370
- 10 81-2015M
- 11 81-2015CL
- 12 81-79550
- 13 81-2015J

Safety Labels

9 81-41370

HYDRAULIC OIL
81-41370 EN

10 81-2015M

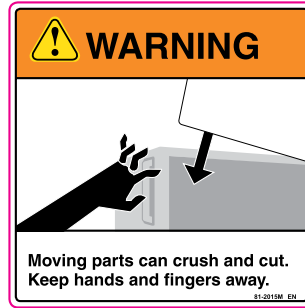

11 81-2015CL

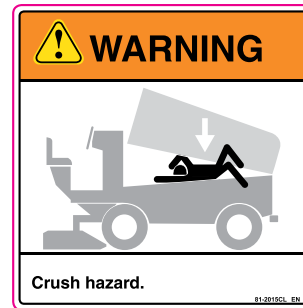

12 81-79950

75 psi / 500 kPa
81-79950

13 81-2015J

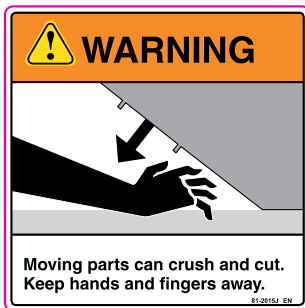

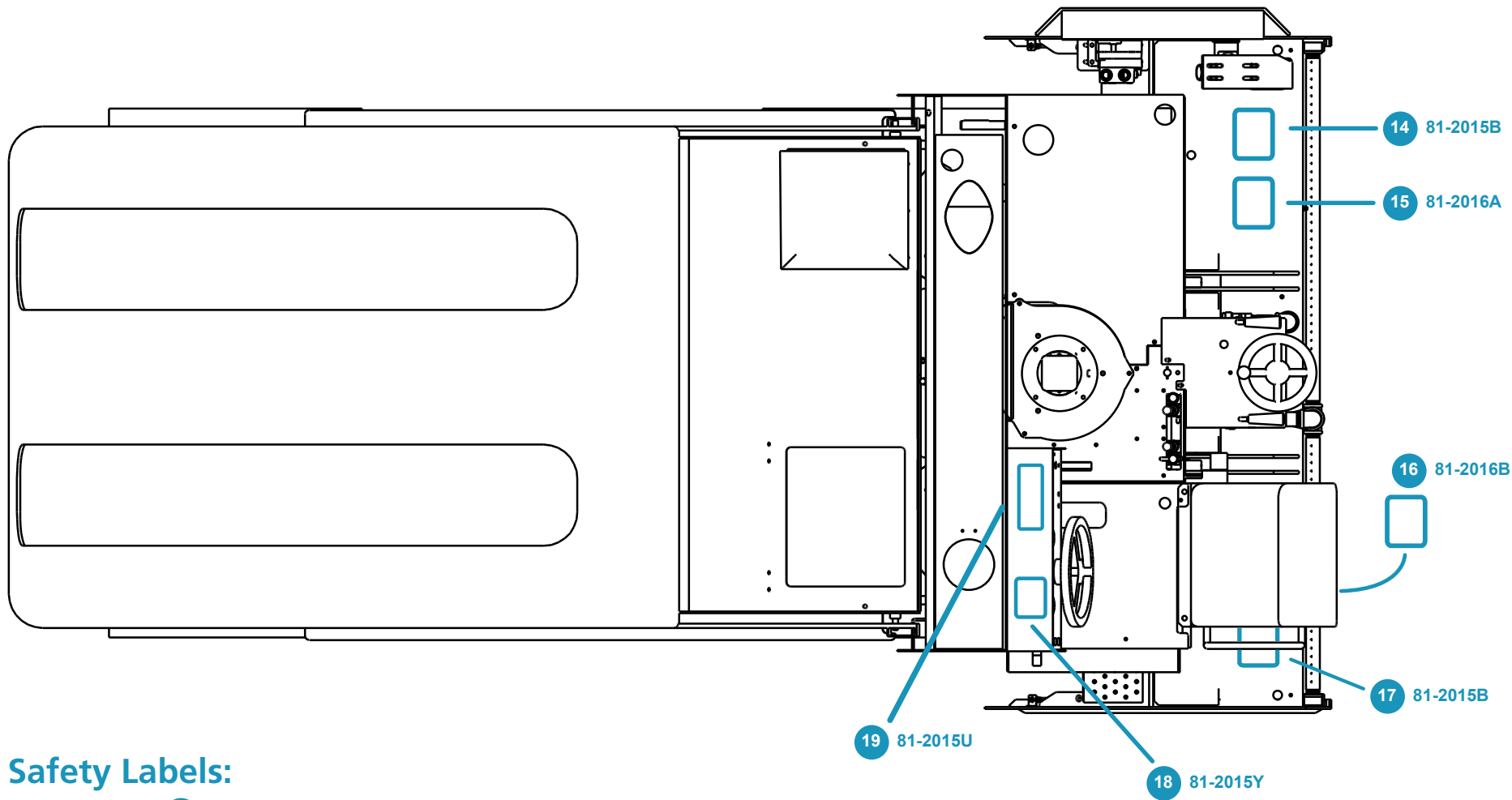

Safety Labels:

- 14 81-2015B
- 15 81-2016A
- 16 81-2016B
- 17 81-2015B
- 18 81-2015Y
- 19 81-2015U

Safety Labels

14 81-2015B

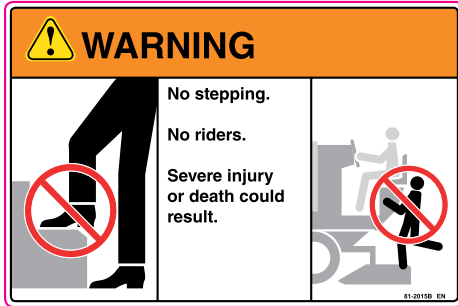

15 81-2016A

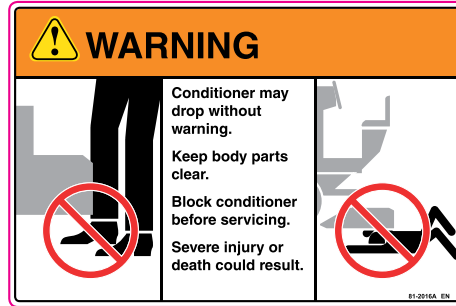

16 81-2016B



17 81-2015B

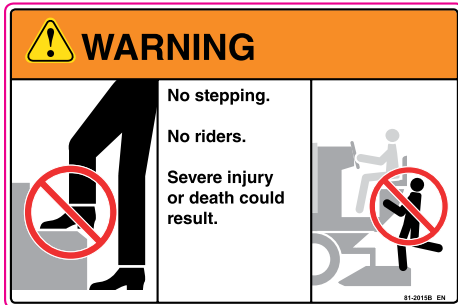

18 81-2015Y

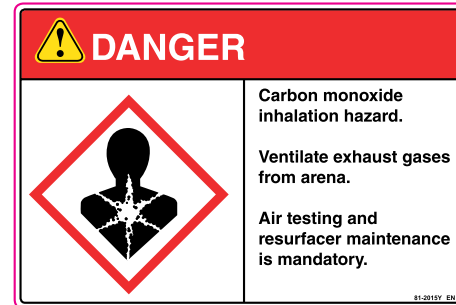

19 81-2015U

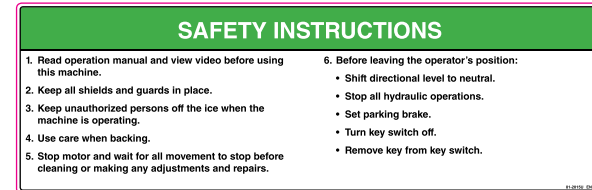

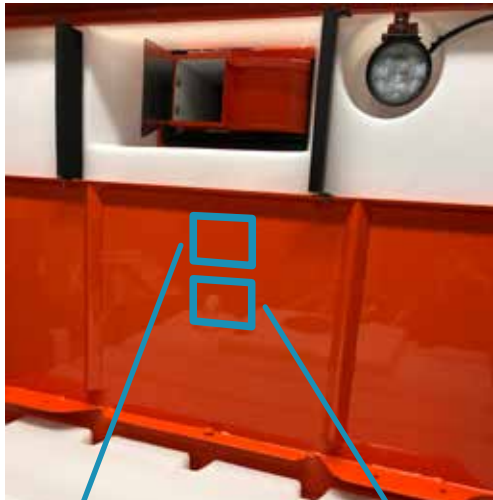

20 81-2015E

21 81-2015Q

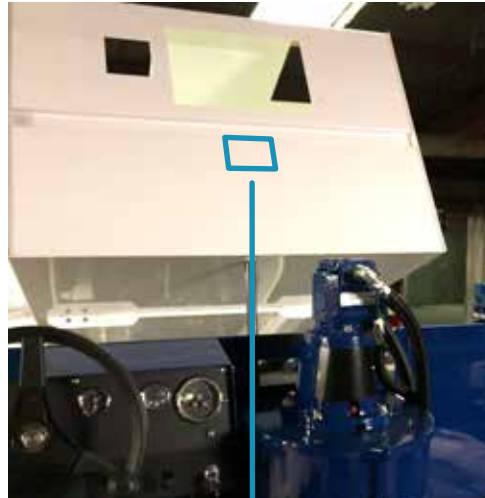

22 81-2015D



23 81-0510A

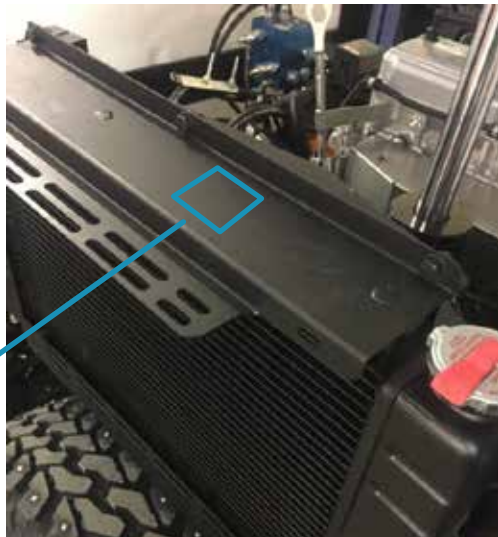

24 81-2015W
(Canadian Machines)

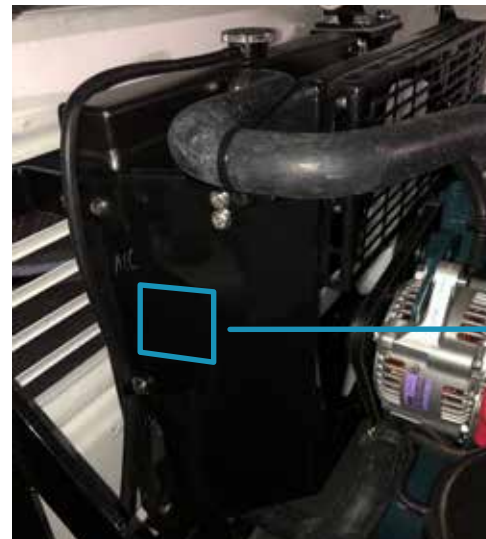

25 81-2015W
(U.S. Machines)

Safety Labels:

- 20 81-2015E
- 21 81-2015Q
- 22 81-2015D
- 23 81-0510A
- 24 81-2015W
- 25 81-2015W

Safety Labels

20 81-2015E

! WARNING	
	Moving augers can cut.
	Keep hands clear.
	<p>All motors must be turned off.</p> <p>Augers may continue to rotate after the power is shut off.</p>
<small>81-2015E EN</small>	

21 81-2015Q

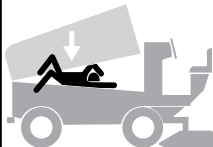
! WARNING	
	Crush hazard.
	Always use safety stand when under raised tank.
	Severe injury may result if safety stand not used.
<small>81-2015Q EN</small>	

22 81-2015D

! WARNING	
	Moving augers can cut.
	Keep hands clear.
	<p>All motors must be turned off.</p> <p>Augers may continue to rotate after the power is shut off.</p>
<small>81-2015D EN</small>	

23 81-2010A

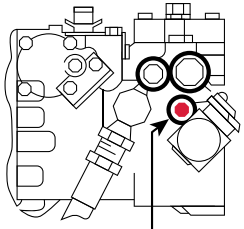
EMERGENCY USE ONLY	
<p>IF ENGINE WILL NOT OPERATE Open red bypass valve 3 turns to move vehicle.</p> <p>WARNING: Valve must be closed for normal use or transmission damage may occur. Torque to 15 lb-ft (20 N·m).</p>	 <p style="text-align: center;"><small>81-0510A EN</small></p>

24 81-2015W

! WARNING	
	
Burn hazard. Add coolant when engine is cool.	
<small>81-2015W EN</small>	

25 81-2015W

! WARNING	
	
Burn hazard. Add coolant when engine is cool.	
<small>81-2015W EN</small>	