

Safety Labels:

- 1 81-2015N
2 81-2015P
3 81-2015G
4 81-2015A
5 81-2015G
6 81-2015F

Safety Labels

1 81-2015N

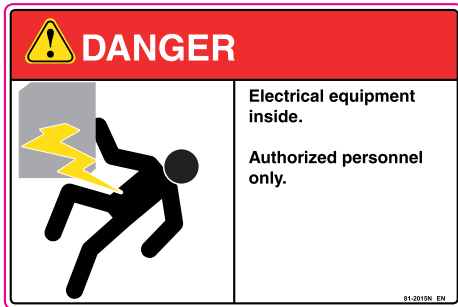

2 81-2015P

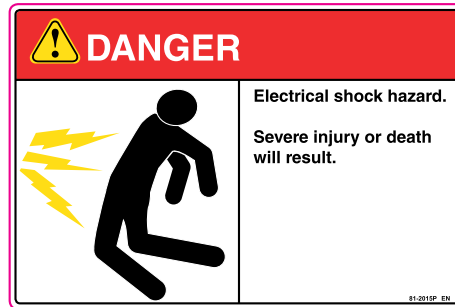

3 81-2015G

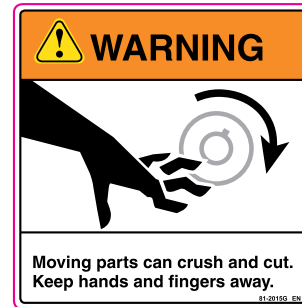

4 81-2015A

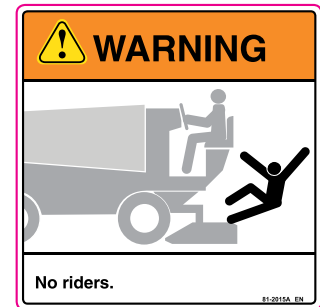

5 81-2015G



6 81-2016F

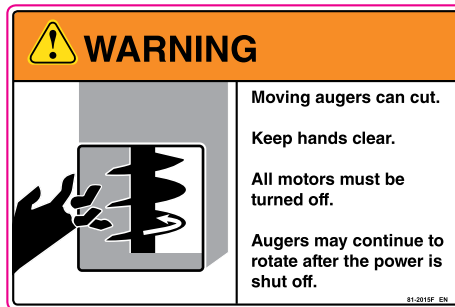

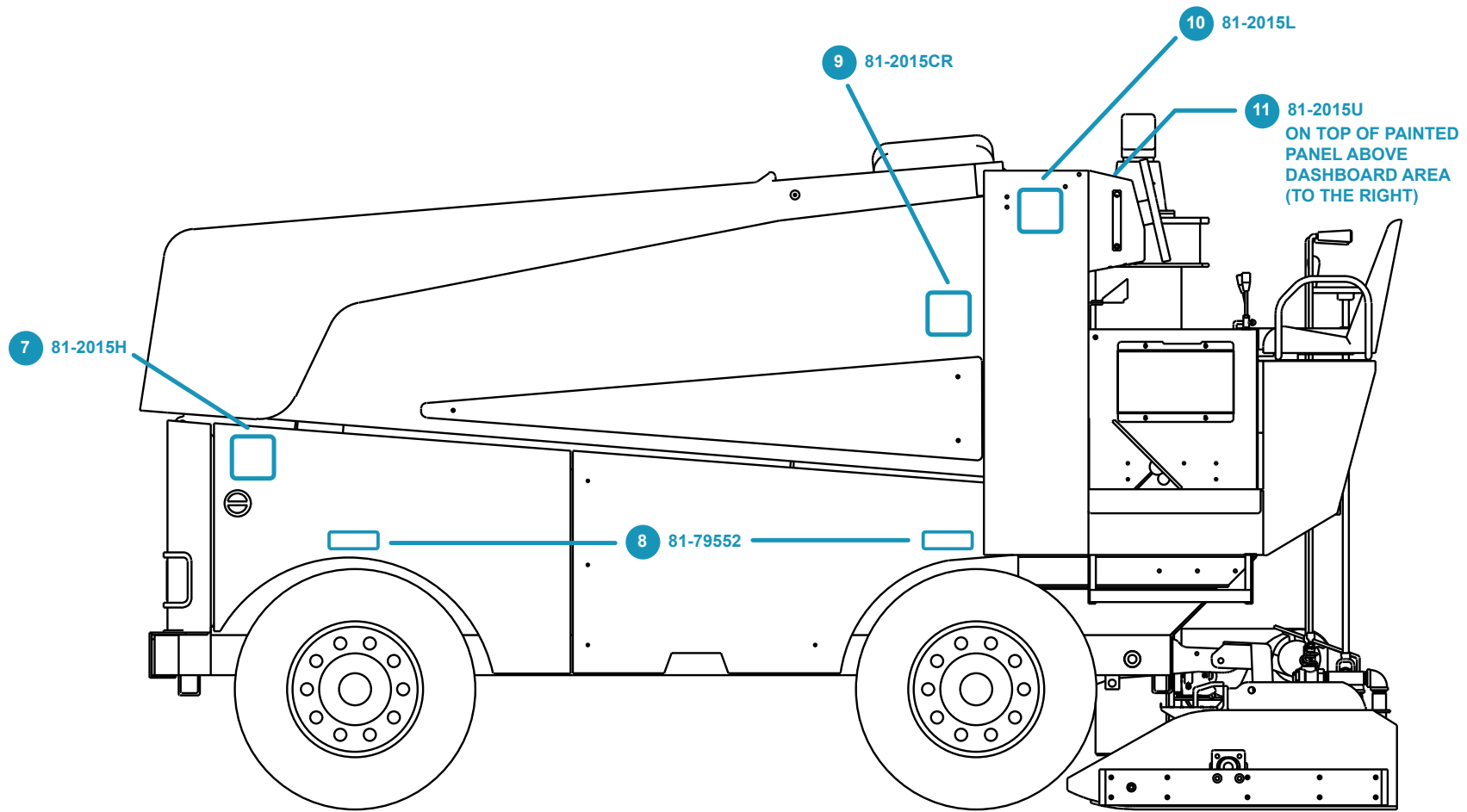

Safety Labels:

- 7 81-2015H
- 8 81-79552
- 9 81-2015CR
- 10 81-2015L
- 11 81-2015U

Safety Labels

7 81-2015H

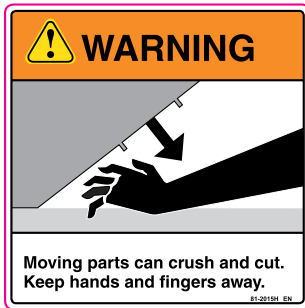

8 81-79952

80 psi / 550 kPa
81-79952

9 81-2015CR



10 81-2015L

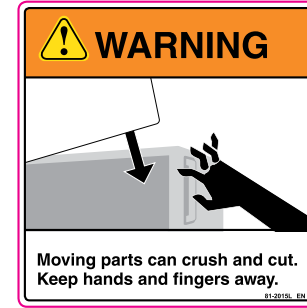

11 81-2015U

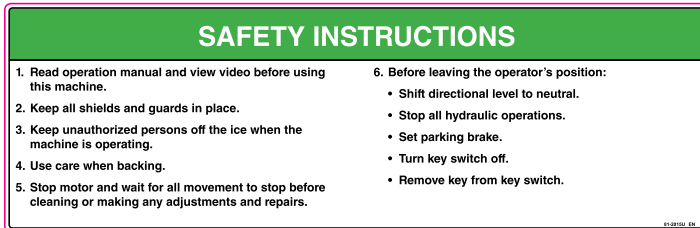

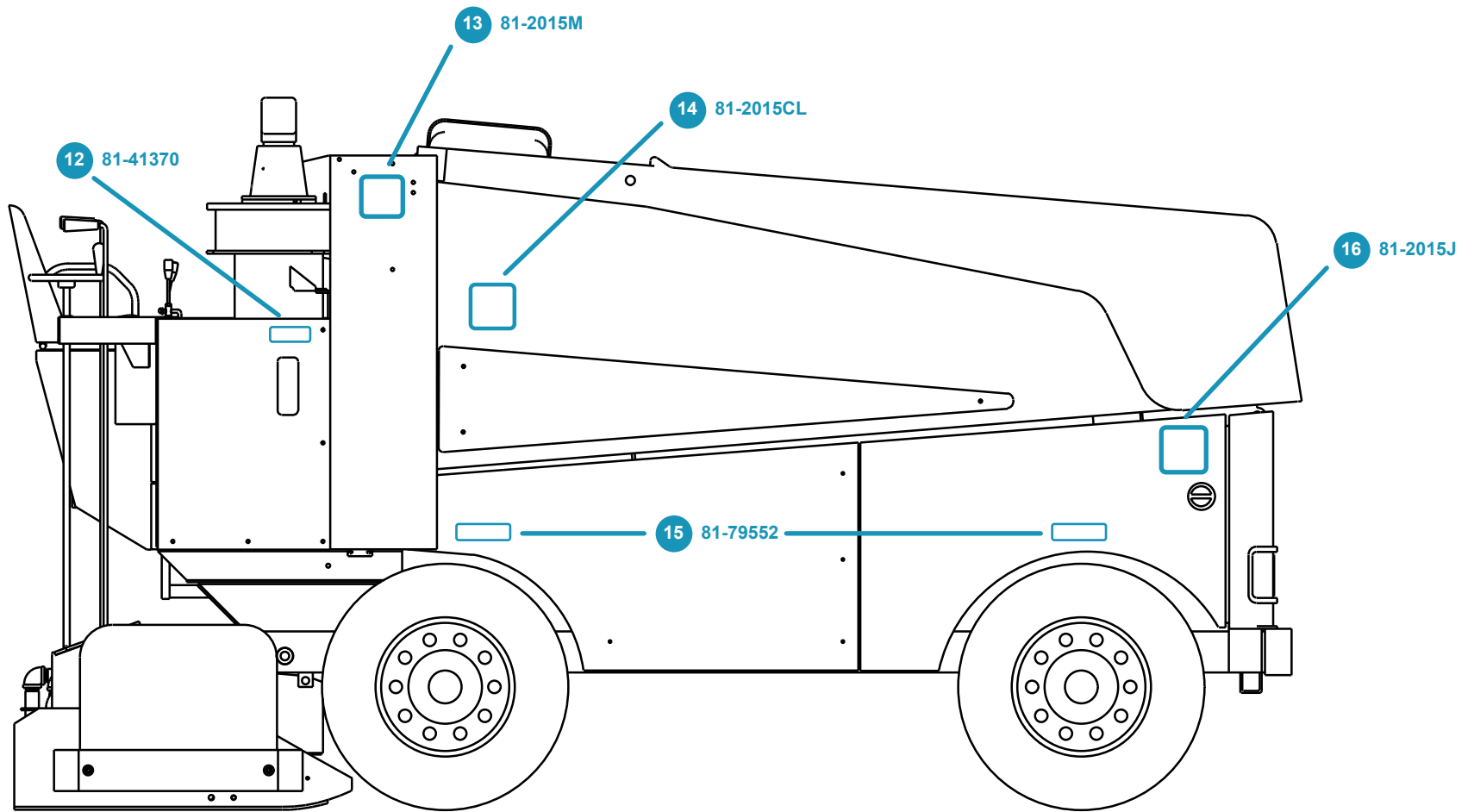

Safety Labels:

- 12 81-41370
- 13 81-2015M
- 14 81-2015CL
- 15 81-79552
- 16 81-2015J

Safety Labels

12 81-41370



13 81-2015M

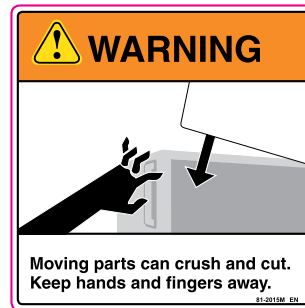

14 81-2015CL

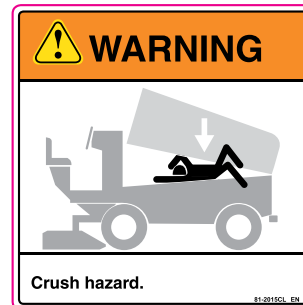

15 81-79952



16 81-2015J

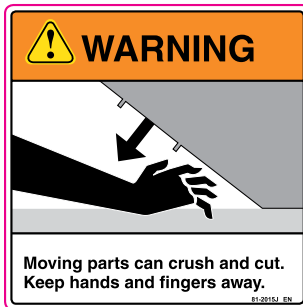

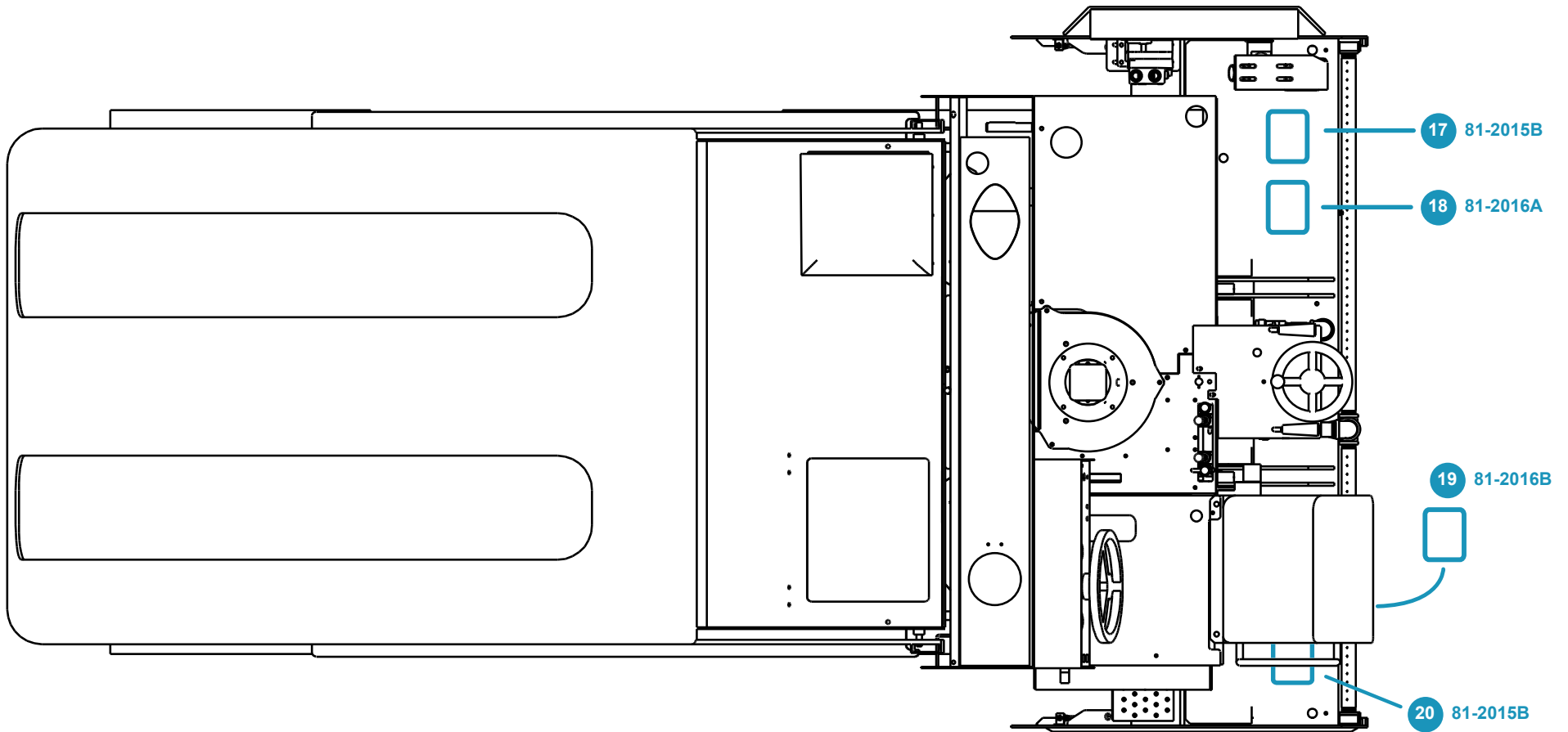

Safety Labels:

- 17 81-2015B
- 18 81-2016A
- 19 81-2016B
- 20 81-2015B

Top View Detail Diagram

Safety Labels

17 81-2015B

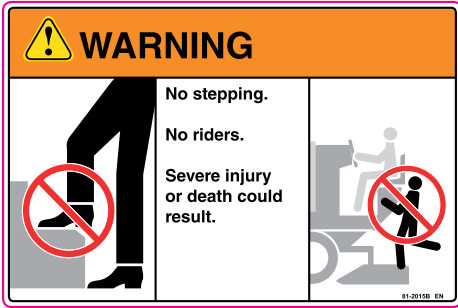

18 81-2016A

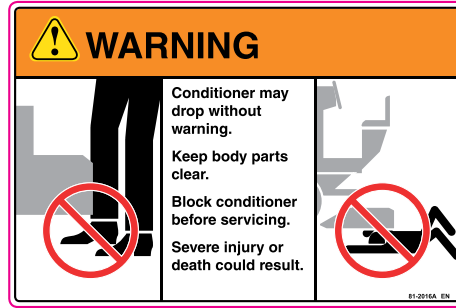

19 81-2016B



20 81-2015B

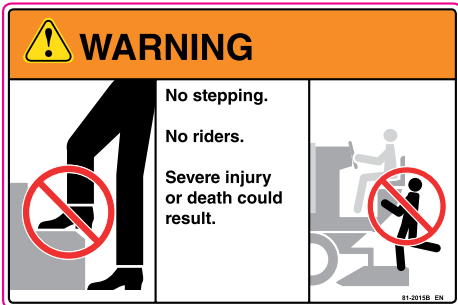

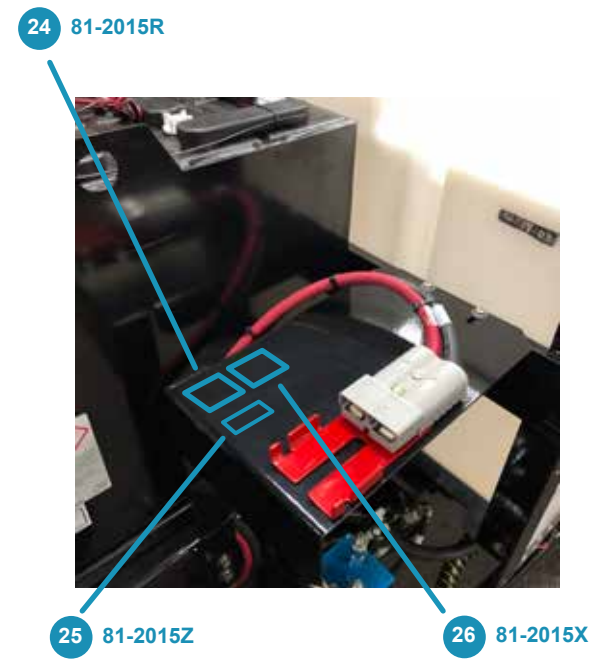
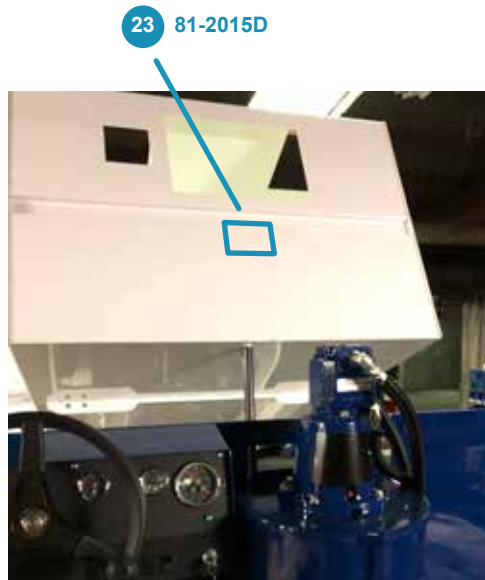
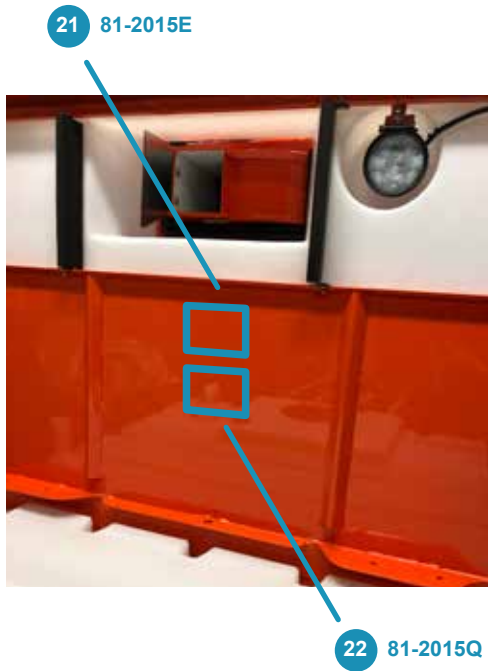

Safety Labels:

- 21 81-2015E
- 22 81-2015Q
- 23 81-2015D
- 24 81-2015R
- 25 81-2015Z
- 26 81-2015X

Safety Labels

21 81-2015E

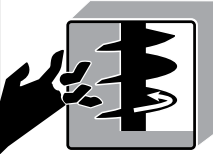
 WARNING	
	Moving augers can cut.
	Keep hands clear.
	All motors must be turned off.
	Augers may continue to rotate after the power is shut off.
<small>81-2015E_EN</small>	

22 81-2015Q

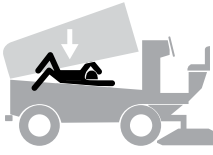
 WARNING	
	Crush hazard.
	Always use safety stand when under raised tank.
	Severe injury may result if safety stand not used.
<small>81-2015Q_EN</small>	

23 81-2015D

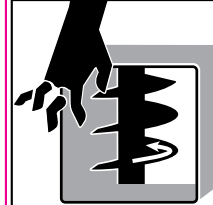
 WARNING	
	Moving augers can cut.
	Keep hands clear.
	All motors must be turned off.
	Augers may continue to rotate after the power is shut off.
<small>81-2015D_EN</small>	

24 81-2015R

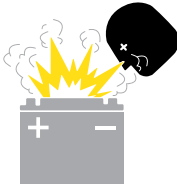
 DANGER	
	Explosion hazard.
	Batteries emit gases.
	Keep flames and sparks away from battery compartment.
<small>81-2015R_EN</small>	

25 81-2015Z

NOTICE
Improper battery operation and service will void battery warranty.
Refer to the operation manual for correct battery operation and service procedures.
<small>81-2015Z_EN</small>

26 81-2015X

SAFE OPERATING PROCEDURES
1. Electric controls are to be serviced by authorized personnel only.
2. Shut off charger before connecting or disconnecting batteries.
3. Disengage battery connectors from machine connectors before attempting any service to motors or electric controls.
4. Charge batteries in a well-ventilated area.
<small>81-2015X_EN</small>